



# SPMX SERIES

*mixers*





# SPMX



MINI



\* SPMX Mini  
Analog Control  
Start/Stop  
Speed Control









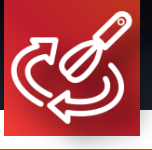



- 1 Digital kontrol - Digital Control - Digitale Steuerung - digitális vezérlés - цифровое управление
- 2 Plastik üst gövde - Plastic top cover - Cubierta plastica arriba - couvercle en plastique - Plastikabdeckung - műanyag fedél - cobertura in plastica - пластиковая крышка
- 3 Paslanmaz ızgara - Stainless steel cover with safety switch - Rejilla de Inox con micro - Griglia in acciaio inossidabile con sicurezza automatica- Rejilla en acier inoxydable avec sécurité automatique - Rejilla de aço inoxidável com segurança automática - Edelstahl-Schüsselabdeckung mit automatischem Sicherheitsschalter - Нержавеющая стальная крышка для миски с автоматическим предохранительным переключателем - Rozsdamentes acél tál fedél automatikus biztonsági kapcsolóval
- 4 Paslanmaz kazan, çapa - Stainless steel bowl and fork - Caldera y aparatos de INOX - Caldaia ed elettrodomestici in acciaio inox - Chaudière et électroménager en inox - Caldeira e eletrodomésticos em inox - Edelstahl-Schüssel und Gabel - Нержавеющая стальная миска и вилка - Rozsdamentes acél tál és villa
- 5 Stoper ve teker - Stopper & wheels - Pies para fijar y ruedas - piedini da fissare e ruote - pieds à fixer et roulettes - pies para fijar y ruedas - Stopper und Räder - стопор и колеса - stopper és kerekek
- 6 Boyalı demir gövde - Body is made of painted iron - Estructura de hierro pintado - Struttura in ferro verniciato - Structure en fer peint- Estrutura de ferro pintadaDie Struktur besteht aus lackiertem Eisen.-Конструкция сделана из окрашенного железа - A szerkezet festett fémből készült
- 7 Yavaş devir - Slow speed/timer adjustment - Ajusto lento y temporizador - Impostazione lenta e timer - Réglage lent et minuterie - onfiguração lenta e temporizador - Langsame Geschwindigkeits-/Timeranpassung - Регулировка медленной скорости/таймера - Lassú sebesség/időzítő beállítás
- 8 Kazan sağ/sol dönüş - Bowl rotation left/right - Schüsselrotation links/rechts - Вращение миски влево/вправо - Tál forgatás balra/jobbra
- 9 Hızlı Devir - Fast speed/timer adjustment - Ajusto rapido y temporizador - Impostazione rapida e timer - Réglage rapide et minuterie- Configuração rápida e temporizador - schnelle Geschwindigkeits-/Timeranpassung - Быстрая настройка скорости/таймера - Gyors sebesség/időzítő beállítás
- 10 Otomatik mod/uyarı ve arıza alarımları - Auto mode and error alarms - Uso automático y alarmas de errores - Allarmi automatici di utilizzo ed errore- Alarmes automatiques d'utilisation et d'erreur - Alarmes automáticos de uso e erro - Automatischer Modus/Fehleralarme - Автоматический режим/сигналы об ошибках - Automatikus üzemmód/hiba riasztások



Mélangeurs A Spirale - Spiralmischer - Impastatrice A Spirale  
 Amassadeira Espiral - Spirális Keverő  
 Спиральный миксер - قماود طالخ



MODEL	 kg	 kg	 lt.	 kw	 kw	 kg	 W	 L	 H	 rpm	 V/hz
SPMX-MINI	5	9	12	0,37		35	300	500	450	105/210/14	220V 50hz
SPMX-25	25	40	70	1.5 / 2.5	0.75	225	530	980	1100	105/210/14	400V 3NPE 50hz
SPMX-40	35	60	100	2.5 / 3.5	0.75	310	640	1080	1300	105/210/14	400V 3NPE 50hz
SPMX-60	65	100	170	3.5 / 5.5	1.1	450	750	1400	1400	105/210/14	400V 3NPE 50hz
SPMX-80	80	130	220	5.5 / 7.5	1.1	530	850	1500	1500	105/210/14	400V 3NPE 50hz
SPMX-120	125	200	340	7.5 / 11	1.5	800	950	1600	1600	105/210/14	400V 3NPE 50hz
SPMX-150	150	250	350	7.5 / 11	1.5	900	1030	1700	1700	105/210/14	400V 3NPE 50hz

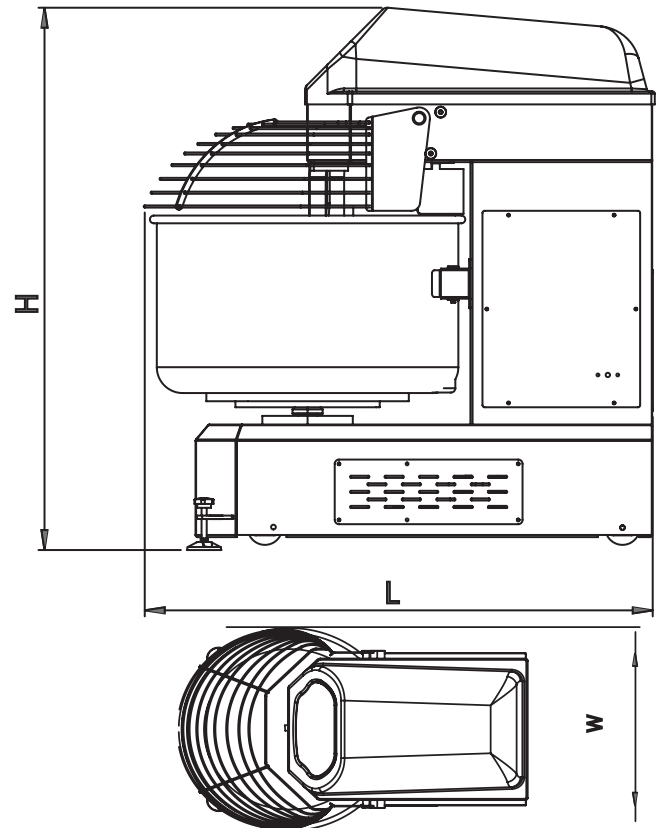
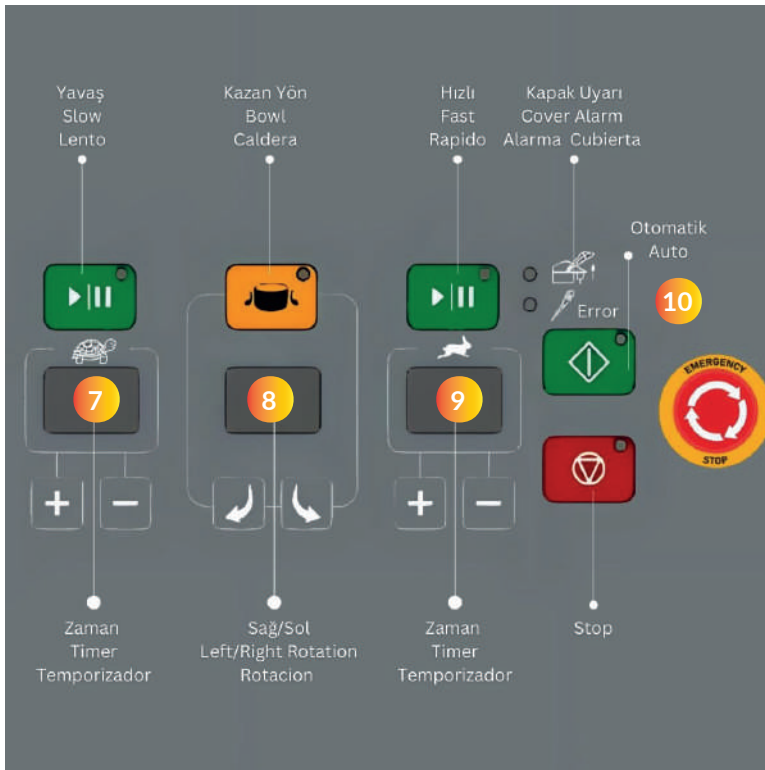
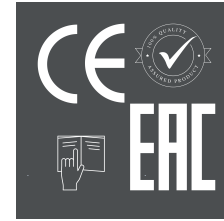
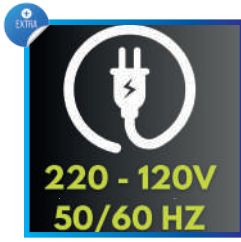



# Contact Us



## PHONE

+90 - 222 236 08 03



## ADDRESS

Eskişehir OSB 8. Cadde No:11  
PO 26110 - Eskişehir/TURKIYE



## MOBILE

+90 - 533 543 07 59



## EMAIL

bilgi@ondermak.com.tr

[www.undermak.com.tr](http://www.undermak.com.tr)

